

F

# Diffusion Boxes & Adaptors

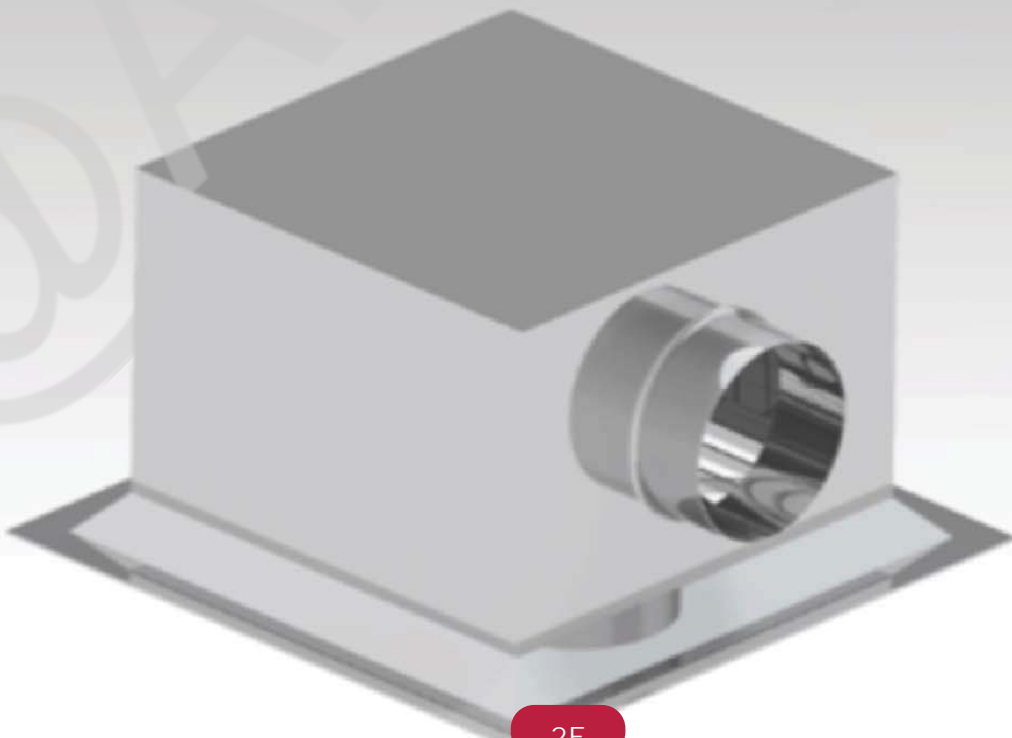

## Saddle for Curved Face Double Deflection Grille

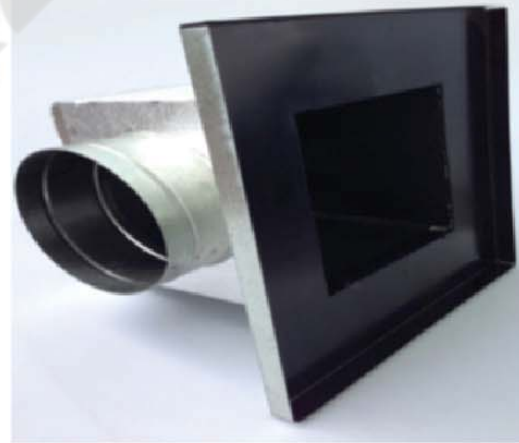
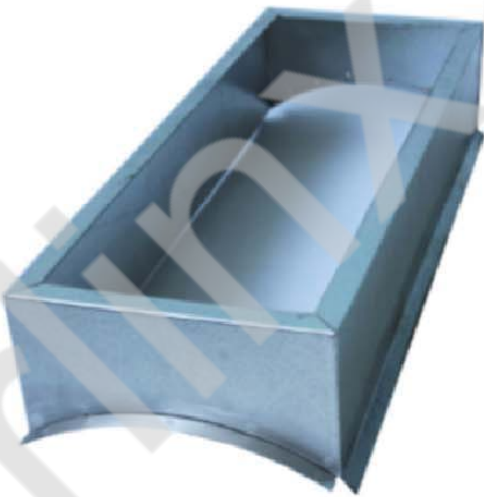
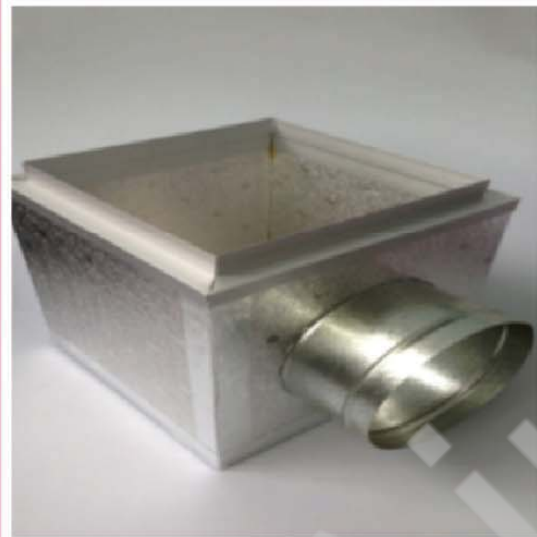

Saddles for Curved Face Grilles are custom made by galvanised metal sheet. It can sit on Spiral duct or oval duct.

Please contact Airlinx for any enquiries

## Diffuser Mounting Frame



Diffuser Mounting Frames are custom made.

Please contact Airlinx for any enquiries.

Aluminium is 1mm thick



**Dulux**

All Metal or Aluminium Grille  
can be Powder Coated.

# Diffusion Boxes & Adaptors

All Boxes are custom made.

Please contact Airlinx for any enquiries

## Plain Cushion Box

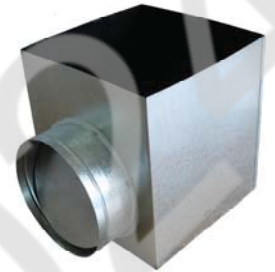

Boxes allow side entry or top entry air connections to diffusers or grilles. When ceiling height is limited, side entry is better option. Flexible duct connections may be either round or oval. Damper can be fit on the pop.

Can be plain with no insulation or insulated. Small sizes of box for ventilation or exhaust purpose, can be plain box.

Contraction: galvanised metal sheet or phenolic board.



## Insulated Cushion Box

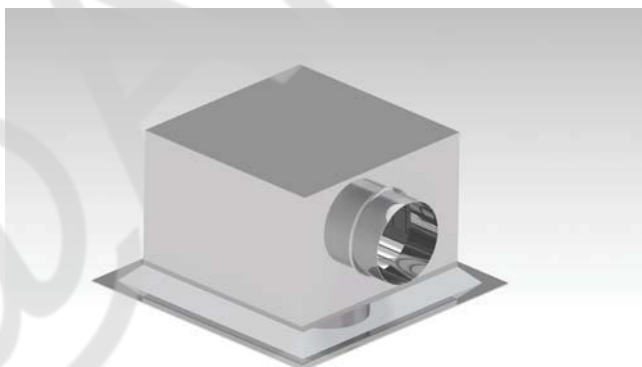



## Adaptor

Diffuser adaptor can Mont on grille neck directly. For a better air flow and limited space in the ceiling, the adaptor can be on a smaller box with adaptor size suits the grille.

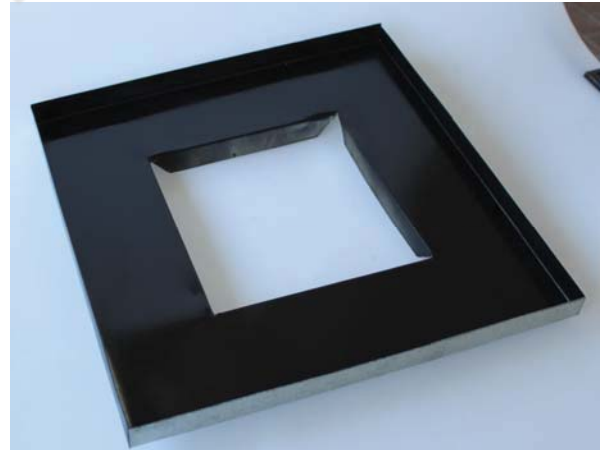
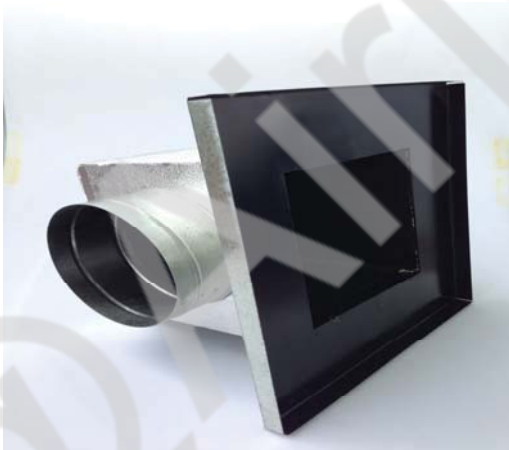

## Linear Slot Boxes



## Swirl Diffuser Box

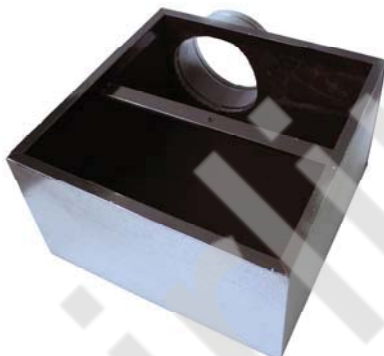

## Phenolic Board Box = R1 Insulated Metal Box

